

TEMPLATES

JIG VGZ 45°

TEMPLATE FOR 45° SCREW CONNECTIONS

- Its shape allows an easy and fast screwing of any type of screw with a precise inclination of 45°
- Thanks to the markings, many typical timber construction connections, both single and double, can easily be made without wasting time on time-consuming measurements

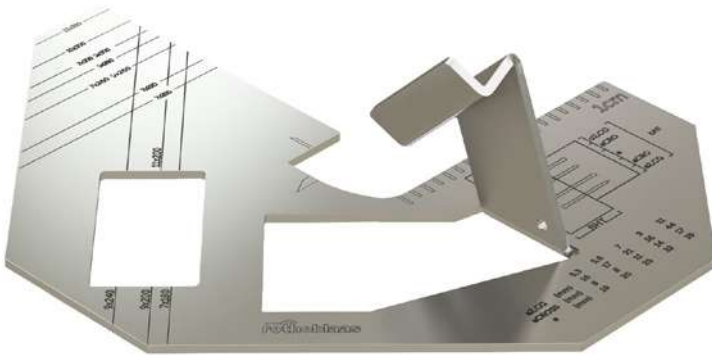

CODES AND DIMENSIONS

CODE	B [mm]	L [mm]	H [mm]	pcs
JIGVGZ45	210	253	67	1



VIDEO

Scan the QR Code and watch the video on our YouTube channel

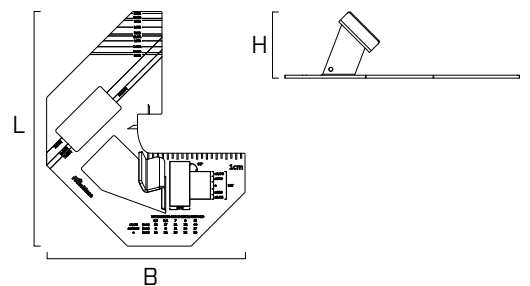

MATERIAL

The template is made of 3 mm stainless steel and is therefore a long-lasting accessory.

FIELDS OF USE

Timber-to-timber joints at 45° for beams and floors

- solid timber
- CLT and LVL
- CTC screw, timber-to-concrete

INSTRUCTIONS FOR ASSEMBLY

SCREW TIP POSITION

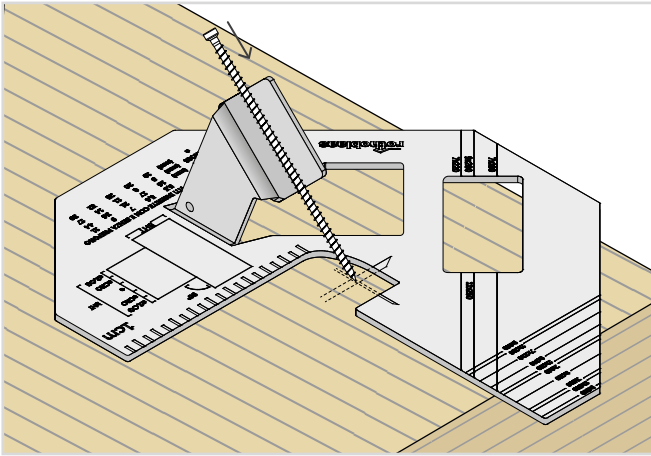

MAIN-BEAM-SECONDARY BEAM JOINT

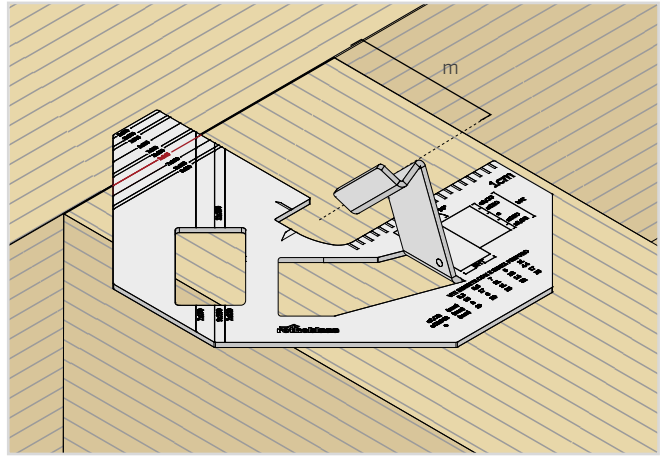

MINIMUM DISTANCE FROM THE EDGE

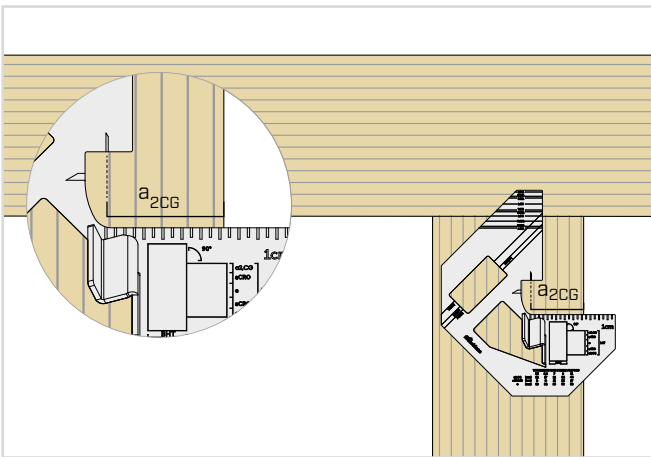

MINIMUM DISTANCES BETWEEN THE SCREWS

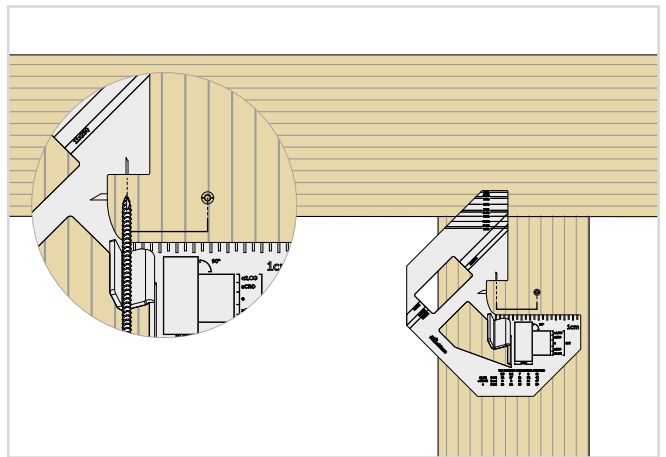

FLOOR-TO-FLOOR JOINT 45° + 45° TO THE RIGHT

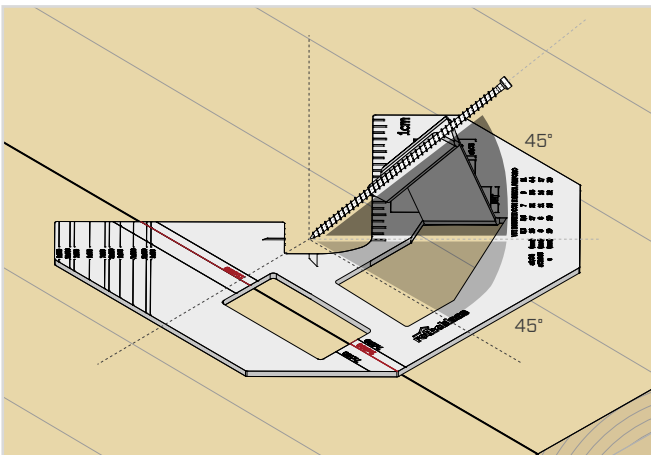

FLOOR-TO-FLOOR JOINT 45° + 45° TO THE LEFT

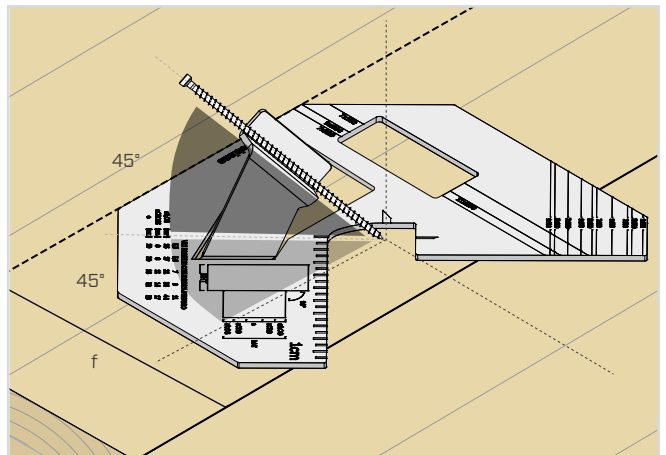

NOTES:

For further information on the use of the template, refer to the assembly instructions available on our website (www.rothoblaas.com).